

1 2 3 4 5 6

A

B

C

D

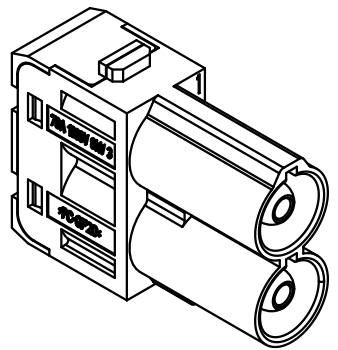
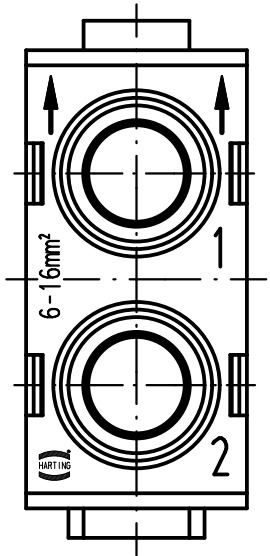
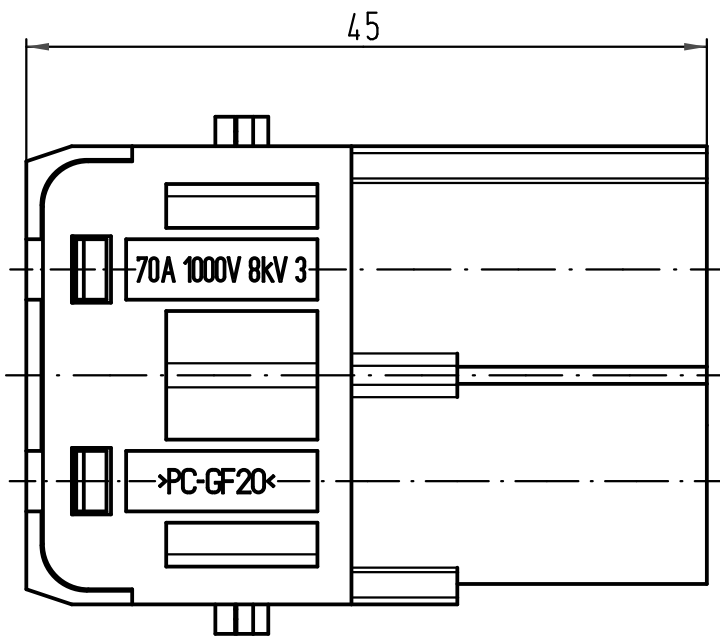
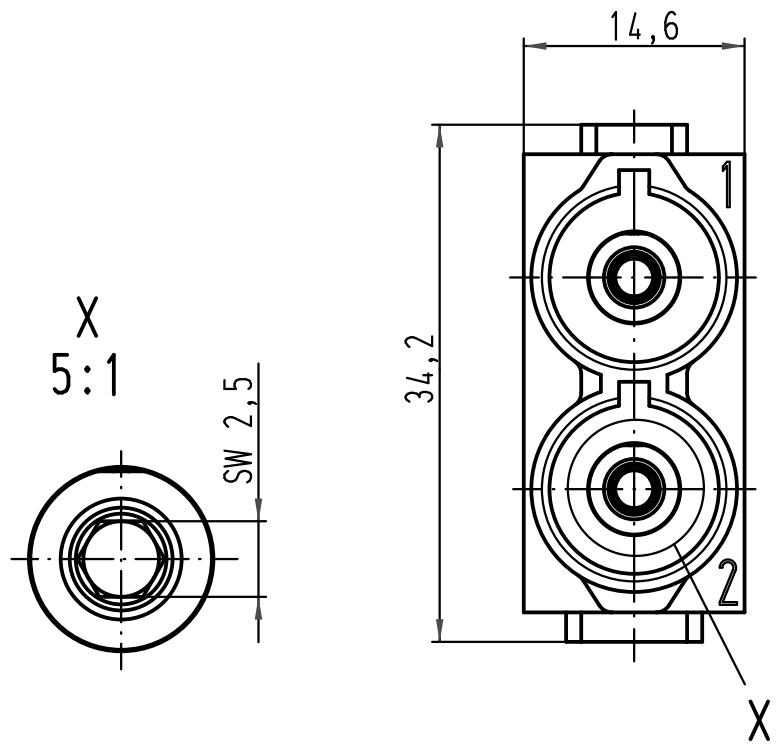

All Dimensions in mm Original Size DIN A 4		Techn. Character.			Nicht tolerierte Masse/ Free size tolerances	
			Dat.	Name	Massstab/ Scale <b>2:1</b> 5:1	<b>Han-Axialschraub-Modul/</b> <i>Han axial screw-module</i> <b>Stifteinsatz (M)/male insert (M)</b>
		Detail.	30.01.07	Ho		
		Insp.		Ole		
		Stand.				
412463		HARTING Electric GmbH & Co. KG				<b>TB 09 14 002 2641</b>
Mod.	Dat.	Name	D-32339 Espelkamp			
					Sub.	